

FEATURES

- Low cost, compact, current-sense solution
- Three available gain versions
 - 20 V/V (ADM4073T)
 - 50 V/V (ADM4073F)
 - 100 V/V (ADM4073H)
- Typical $\pm 1.0\%$ full-scale accuracy
- 500 μA supply current
- Wide 1.8 MHz bandwidth
- 3 V to 28 V operating supply
- Wide 2 V to 28 V common-mode range
- Independent of supply voltage
- Operates from -40°C to $+125^\circ\text{C}$
- Available in a 6-lead SOT-23 package
- Pin-to-pin compatibility with the MAX4073

APPLICATIONS

- Cell phones, PDAs
- Notebook computers
- Portable/battery-powered systems
- Smart battery packs/chargers
- Automotive
- Power management systems
- PA bias control
- General system/board-level current monitoring
- Precision current sources

GENERAL DESCRIPTION

The ADM4073 is a low cost, high-side, current-sense amplifier ideal for small portable applications such as cell phones, notebook computers, PDAs, and other systems where current monitoring is required. The device is available in three different gain models, eliminating the need for gain-setting resistors. Because the ground path is not interrupted, the ADM4073 is particularly useful in rechargeable battery-powered systems, while its wide 1.8 MHz bandwidth makes it suitable for use inside battery-charger control loops. The input common-mode range of 2 V to 28 V is independent of the supply voltage.

FUNCTIONAL BLOCK DIAGRAM

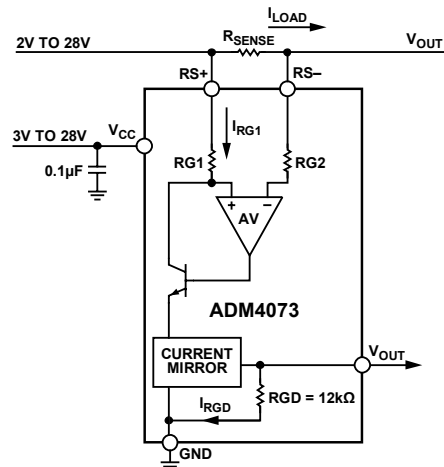

Figure 1.

05131-003

APPLICATION DIAGRAM

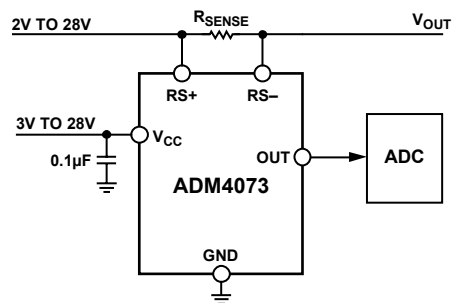

Figure 2.

05131-001

The voltage on the output pin is determined by the current flowing through the selectable external sense resistor and the gain of the version selected. The operating range is 3 V to 28 V with a typical supply current of 500 μA . The ADM4073 is available in a 6-lead SOT-23 package and is specified over the automotive operating temperature range (-40°C to $+125^\circ\text{C}$).

Rev. 0

Information furnished by Analog Devices is believed to be accurate and reliable. However, no responsibility is assumed by Analog Devices for its use, nor for any infringements of patents or other rights of third parties that may result from its use. Specifications subject to change without notice. No license is granted by implication or otherwise under any patent or patent rights of Analog Devices. Trademarks and registered trademarks are the property of their respective owners.

TABLE OF CONTENTS

| | | | |
|--------------------------------|---|--|----|
| Features | 1 | ESD Caution..... | 4 |
| Applications..... | 1 | Pin Configuration and Function Descriptions..... | 5 |
| Functional Block Diagram | 1 | Typical Performance Characteristics | 6 |
| Application Diagram..... | 1 | Theory of Operation | 10 |
| General Description | 1 | R_{SENSE} | 10 |
| Revision History | 2 | Output (OUT)..... | 10 |
| Specifications..... | 3 | Outline Dimensions | 11 |
| Absolute Maximum Ratings..... | 4 | Ordering Guide | 11 |
| Thermal Characteristics | 4 | | |

REVISION HISTORY

7/06—Revision 0: Initial Version

SPECIFICATIONS

$V_{RS+} = 2\text{ V to } 28\text{ V}$, $V_{SENSE} = (V_{RS+} - V_{RS-}) = 0$, $V_{CC} = 3\text{ V to } 28\text{ V}$, $T_A = -40^\circ\text{C to } +125^\circ\text{C}$, unless otherwise noted. Typical values are at $T_A = 25^\circ\text{C}$.¹

Table 1.

| Parameter | Min | Typ | Max | Unit | Conditions |
|---|-----------|-----------|-----------|---------------|---|
| POWER SUPPLY | | | | | |
| Operating Voltage Range, V_{CC} | 3 | | 28 | V | Inferred from PSRR test |
| Common-Mode Input Range, V_{CMR} | 2 | | 28 | V | Inferred OUT voltage error test |
| Common-Mode Input Rejection, CMR | | 90 | | dB | $V_{SENSE} = 100\text{ mV}$, $V_{CC} = 12\text{ V}$ |
| Supply Current, I_{CC} | | 0.5 | 1.2 | mA | $V_{CC} = 28\text{ V}$ |
| Leakage Current, I_{RS+}/I_{RS-} | | 0.05 | 2 | μA | $V_{CC} = 0\text{ V}$, $V_{RS+} = 28\text{ V}$, $T_A = 85^\circ\text{C}$ |
| Input Bias Current, I_{RS+} | | 20 | 60 | μA | |
| Input Bias Current, I_{RS-} | | 40 | 120 | μA | |
| Full Scale Sense Voltage, V_{SENSE} | | 150 | | mV | $V_{SENSE} = (V_{RS+} - V_{RS-})$ |
| Total Out Voltage Error ² | ± 1 | | | % | $V_{SENSE} = 100\text{ mV}$, $V_{CC} = 12\text{ V}$, $V_{RS+} = 2\text{ V}$ |
| | ± 1.0 | ± 5.0 | | % | $V_{SENSE} = 100\text{ mV}$, $V_{CC} = 12\text{ V}$, $V_{RS+} = 12\text{ V}$, $T_A = +25^\circ\text{C}$ |
| | | | ± 5.0 | % | $V_{SENSE} = 100\text{ mV}$, $V_{CC} = 12\text{ V}$, $V_{RS} = 12\text{ V}$, $T_A = -40^\circ\text{C to } +125^\circ\text{C}$ |
| | ± 1.0 | ± 5.0 | | % | $V_{SENSE} = 100\text{ mV}$, $V_{CC} = 28\text{ V}$, $V_{RS} = 28\text{ V}$, $T_A = +25^\circ\text{C}$ |
| | | | ± 5.0 | % | $V_{SENSE} = 100\text{ mV}$, $V_{CC} = 28\text{ V}$, $V_{RS} = 28\text{ V}$, $T_A = -40^\circ\text{C to } +125^\circ\text{C}$ |
| | ± 7.5 | | | % | $V_{SENSE} = 6.25\text{ mV}$, ³ $V_{CC} = 12\text{ V}$, $V_{RS} = 12\text{ V}$ |
| Extrapolated Input Offset Voltage, V_{OS} | 1.0 | | | mV | $V_{CC} = V_{RS+} = 12\text{ V}$, $V_{SENSE} > 10\text{ mV}$ |
| Out High Voltage ($V_{CC} - V_{OH}$) | 0.8 | 1.2 | | V | $V_{CC} = 3\text{ V}$, $V_{SENSE} = 150\text{ mV}$ (ADM4073T) |
| | 0.8 | 1.2 | | V | $V_{CC} = 7.5\text{ V}$, $V_{SENSE} = 150\text{ mV}$ (ADM4073F) |
| | 0.8 | 1.2 | | V | $V_{CC} = 15\text{ V}$, $V_{SENSE} = 150\text{ mV}$ (ADM4073H), $T_A = 25^\circ\text{C}$ |
| DYNAMIC CHARACTERISTICS | | | | | |
| Bandwidth, BW | | 1.8 | | MHz | $V_{SENSE} = 100\text{ mV}$, $V_{CC} = 12\text{ V}$, $V_{RS+} = 12\text{ V}$, $C_{LOAD} = 5\text{ pF}$ (ADM4073T) |
| | | 1.7 | | MHz | $V_{SENSE} = 100\text{ mV}$, $V_{CC} = 12\text{ V}$, $V_{RS+} = 12\text{ V}$, $C_{LOAD} = 5\text{ pF}$ (ADM4073F) |
| | | 1.6 | | MHz | $V_{SENSE} = 100\text{ mV}$, $V_{CC} = 12\text{ V}$, $V_{RS+} = 12\text{ V}$, $C_{LOAD} = 5\text{ pF}$ (ADM4073H) |
| Gain, A_v | | 600 | | kHz | $V_{SENSE} = 6.25\text{ mV}$, ³ $V_{CC} = 12\text{ V}$, $V_{RS+} = 12\text{ V}$, $C_{LOAD} = 5\text{ pF}$ (ADM4073T/F/H) |
| | | 20 | | V/V | ADM4073T |
| | | 50 | | V/V | ADM4073F |
| Gain Accuracy, dA_v | | 100 | | V/V | ADM4073H |
| | ± 1.0 | ± 2.0 | | % | $V_{SENSE} = 10\text{ mV to } 150\text{ mV}$, $V_{CC} = 12\text{ V}$, $V_{RS+} = 12\text{ V}$, $T_A = +25^\circ\text{C}$ (ADM4073T/F) |
| | | | ± 2.0 | % | $V_{SENSE} = 10\text{ mV to } 150\text{ mV}$, $V_{CC} = 12\text{ V}$, $V_{RS+} = 12\text{ V}$, $T_A = -40^\circ\text{C to } +125^\circ\text{C}$ (ADM4073T/F) |
| | ± 1.0 | ± 1.5 | | % | $V_{SENSE} = 10\text{ mV to } 100\text{ mV}$, $V_{CC} = 12\text{ V}$, $V_{RS+} = 12\text{ V}$, $T_A = +25^\circ\text{C}$ (ADM4073H) |
| OUT Settling Time to 1% of Final Value | | | ± 3.0 | % | $V_{SENSE} = 10\text{ mV to } 100\text{ mV}$, $V_{CC} = 12\text{ V}$, $V_{RS+} = 12\text{ V}$, $T_A = -40^\circ\text{C to } +125^\circ\text{C}$ (ADM4073H) |
| | | 400 | | ns | $V_{SENSE} = 6.25\text{ mV to } 100\text{ mV}$, $V_{CC} = 12\text{ V}$, $V_{RS+} = 12\text{ V}$, $C_{LOAD} = 5\text{ pF}$ |
| | | 800 | | ns | $V_{SENSE} = 100\text{ mV to } 6.25\text{ mV}$, $V_{CC} = 12\text{ V}$, $V_{RS+} = 12\text{ V}$, $C_{LOAD} = 5\text{ pF}$ |
| Output Resistance, R_{OUT} | | 12 | | k Ω | |
| Power Supply Rejection Ratio, PSRR | | 78 | | dB | $V_{SENSE} = 60\text{ mV}$, $V_{CC} = 3\text{ V to } 28\text{ V}$ (ADM4073T) |
| | | 85 | | dB | $V_{SENSE} = 24\text{ mV}$, $V_{CC} = 3\text{ V to } 28\text{ V}$ (ADM4073F) |
| | | 90 | | dB | $V_{SENSE} = 12\text{ mV}$, $V_{CC} = 3\text{ V to } 28\text{ V}$ (ADM4073H) |
| Power-Up Time ⁴ | | 5 | | μs | $C_{LOAD} = 5\text{ pF}$, $V_{SENSE} = 100\text{ mV}$ |
| Saturation Recovery Time ⁵ | | 5 | | μs | $C_{LOAD} = 5\text{ pF}$, $V_{CC} = 12\text{ V}$, $V_{RS+} = 12\text{ V}$ |

¹ 100% production tested at $T_A = 25^\circ\text{C}$. Specifications over temperature limit are guaranteed by design.

² Total out voltage error is the sum of the gain and offset errors.

³ $6.25\text{ mV} = 1/16^{\text{th}}$ of 100 mV full-scale sense voltage.

⁴ Output settles to within 1% of final value.

⁵ The device does not experience phase reversal when overdriven.

ADM4073

ABSOLUTE MAXIMUM RATINGS

Table 2.

| Parameter | Rating |
|---|-------------------------------------|
| V _{CC} to GND | −0.3 V to +30 V |
| RS± to GND | −0.3 V to +30 V |
| OUT to GND | −0.3 V to (V _{CC} + 0.3 V) |
| OUT Short-Circuit to GND | Continuous |
| Differential Input Voltage (V _{RS+} − V _{RS-}) | ±5 V |
| Current into any Pin | ±20 mA |
| Storage Temperature Range | −65°C to +125°C |
| Operating Temperature Range | −40°C to +125°C |
| Lead Temperature, Soldering (10 sec) | 300°C |
| Junction Temperature | 150°C |

Stresses above those listed under Absolute Maximum Ratings may cause permanent damage to the device. This is a stress rating only; functional operation of the device at these or any other conditions above those indicated in the operational section of this specification is not implied. Exposure to absolute maximum rating conditions for extended periods may affect device reliability.

THERMAL CHARACTERISTICS

θ_{JA} is specified for the worst-case conditions, that is, a device soldered in a circuit board for surface-mount packages.

Table 3. Thermal Resistance

| Package Type | θ_{JA} | Unit |
|---------------|---------------|------|
| 6-Lead SOT-23 | 169.5 | °C/W |

ESD CAUTION

ESD (electrostatic discharge) sensitive device. Electrostatic charges as high as 4000 V readily accumulate on the human body and test equipment and can discharge without detection. Although this product features proprietary ESD protection circuitry, permanent damage may occur on devices subjected to high energy electrostatic discharges. Therefore, proper ESD precautions are recommended to avoid performance degradation or loss of functionality.



PIN CONFIGURATION AND FUNCTION DESCRIPTIONS

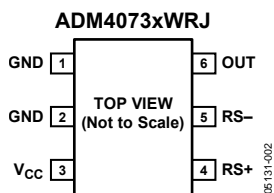

Figure 3. Pin Configuration

Table 4. Pin Function Descriptions

| Pin No. | Mnemonic | Description |
|---------|-----------------|---|
| 1, 2 | GND | Chip Ground Pin. |
| 3 | V _{CC} | Chip Power Supply. Requires a 0.1μF capacitor to ground. |
| 4 | RS+ | Power-Side Connection to the External Sense Resistor. |
| 5 | RS- | Load-Side Connection to the External Sense Resistor. |
| 6 | OUT | Voltage Output. V _{OUT} is proportional to V _{SENSE} . Output impedance is approximately 12 kΩ. |

TYPICAL PERFORMANCE CHARACTERISTICS

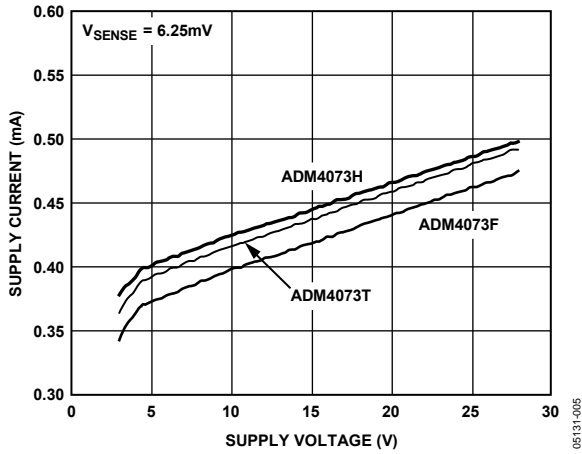

Figure 4. Supply Current vs. Supply Voltage ($V_{SENSE} = 6.25mV$)

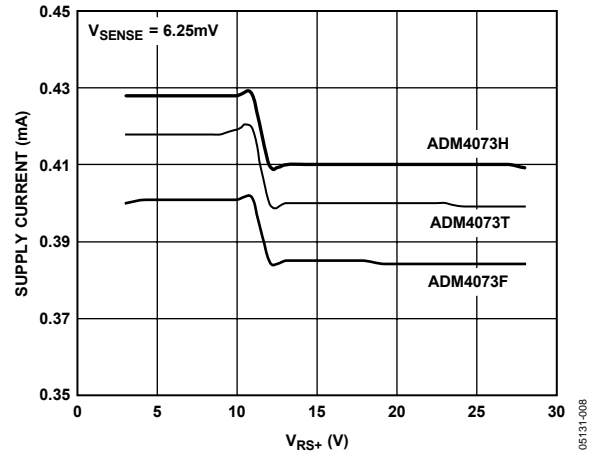

Figure 7. Supply Current vs. R_{S+} Voltage ($V_{SENSE} = 6.25mV$)

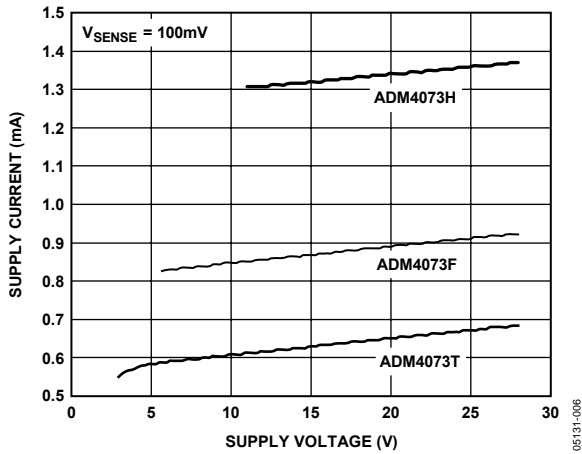

Figure 5. Supply Current vs. Supply Voltage ($V_{SENSE} = 100mV$)

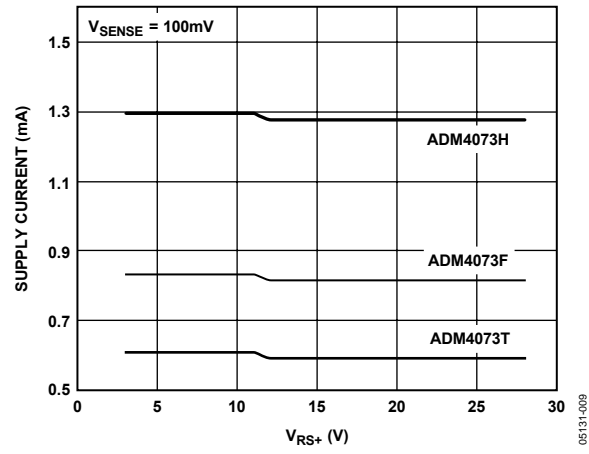

Figure 8. Supply Current vs. R_{S+} Voltage ($V_{SENSE} = 100mV$)

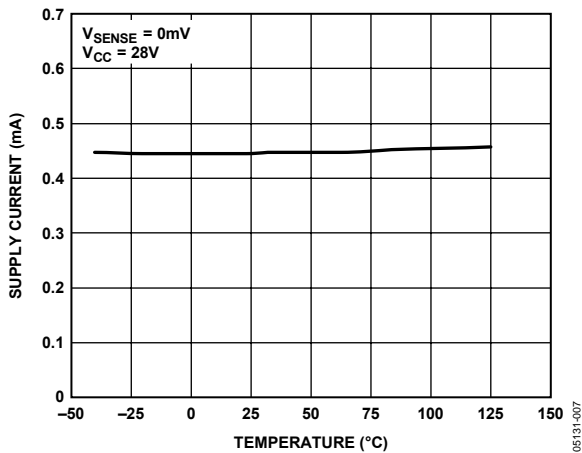

Figure 6. Supply Current vs. Temperature

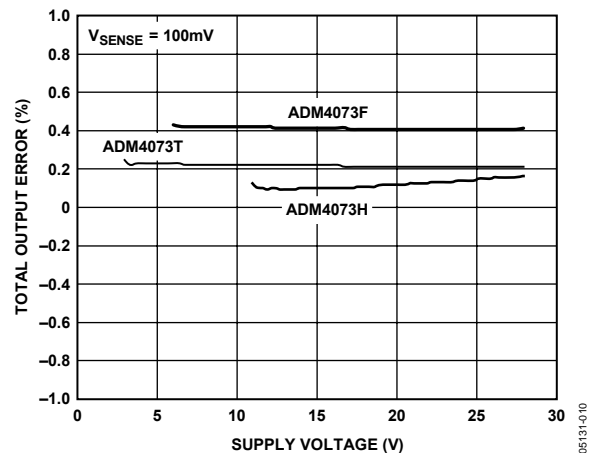

Figure 9. Total Output Error vs. Supply Voltage ($V_{SENSE} = 100mV$)

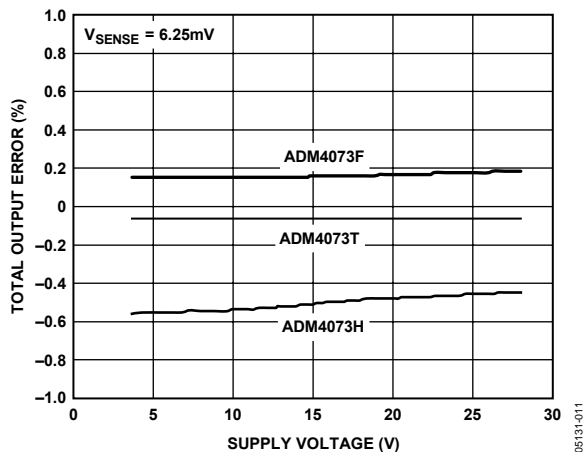

Figure 10. Total Output Error vs. Supply Voltage ($V_{SENSE} = 6.25\text{mV}$)

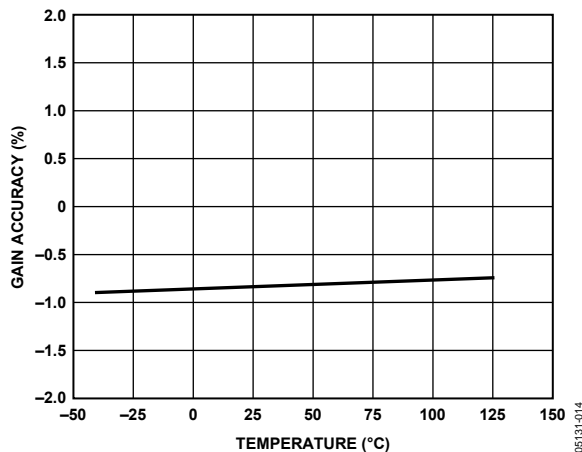

Figure 13. Gain Accuracy vs. Temperature

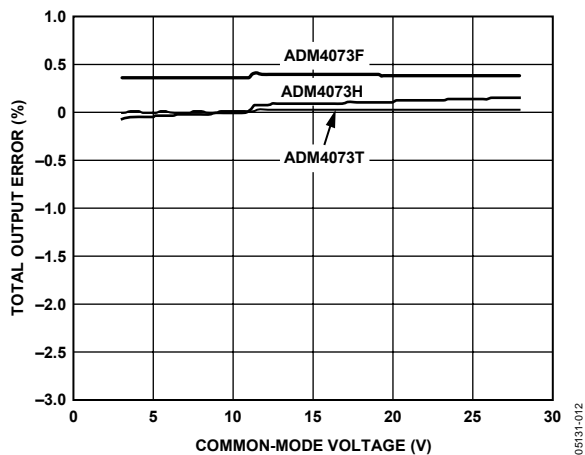

Figure 11. Total Output Error vs. Common-Mode Voltage

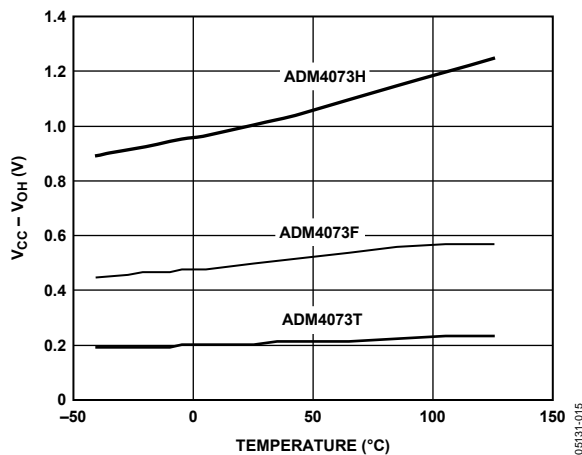

Figure 14. O/P High Voltage ($V_{CC} - V_{OH}$) vs. Temperature

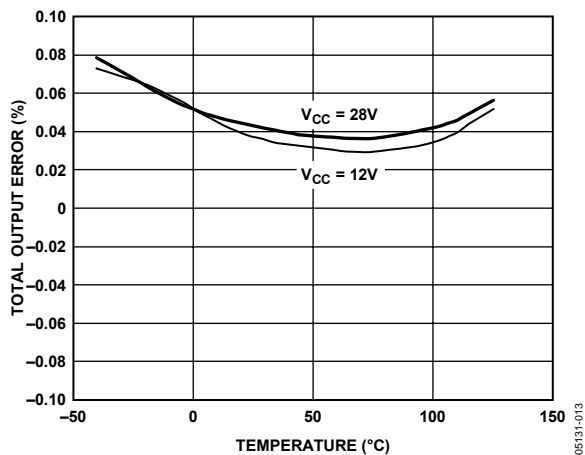

Figure 12. Total Output Error vs. Temperature

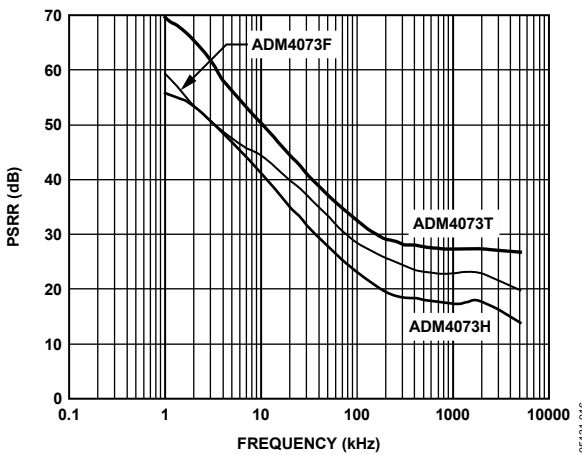

Figure 15. PSRR vs. Frequency

ADM4073

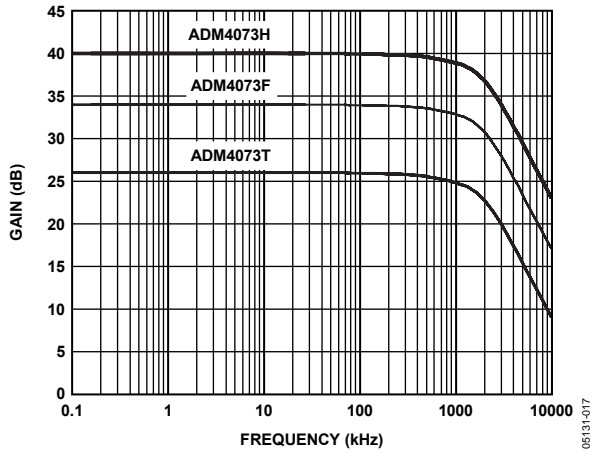

Figure 16. Small Signal Gain vs. Frequency

05131-017

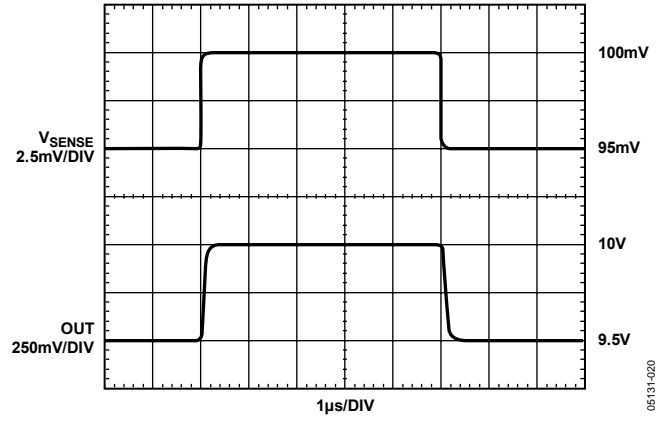

Figure 19. ADM4073H Small Signal Transient Response

05131-020

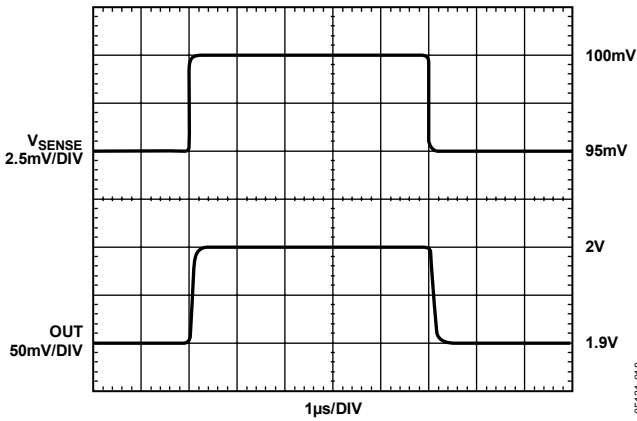

Figure 17. ADM4073T Small Signal Transient Response

05131-018

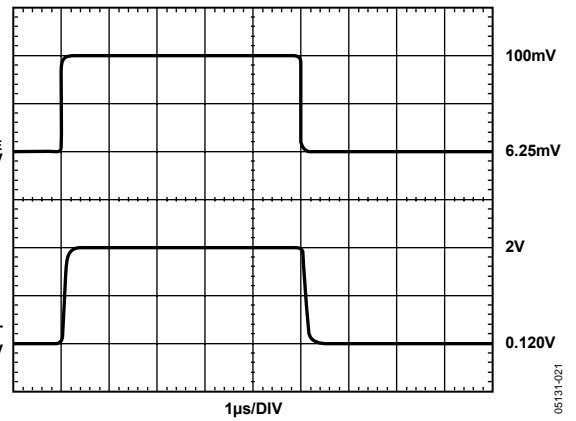

Figure 20. ADM4073T Large Signal Transient Response

05131-021

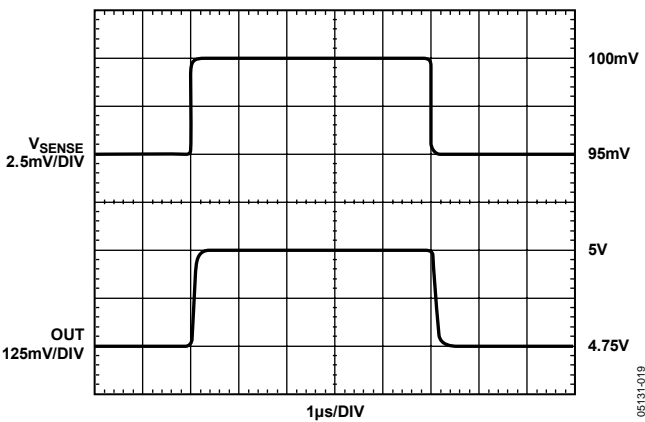

Figure 18. ADM4073F Small Signal Transient Response

05131-019

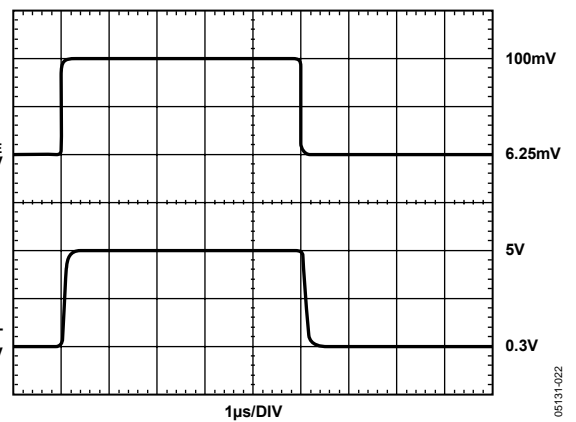

Figure 21. ADM4073F Large Signal Transient Response

05131-022

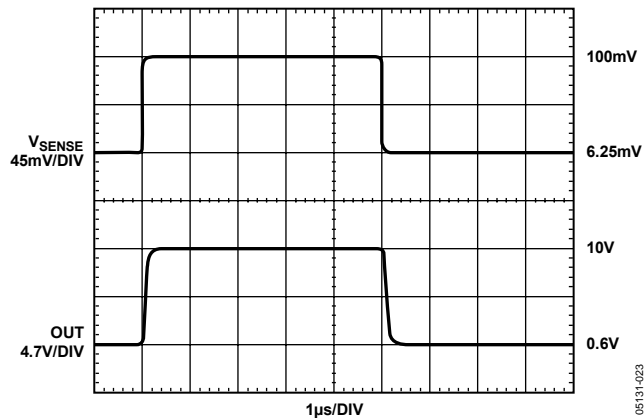

Figure 22. ADM4073H Large Signal Transient Response

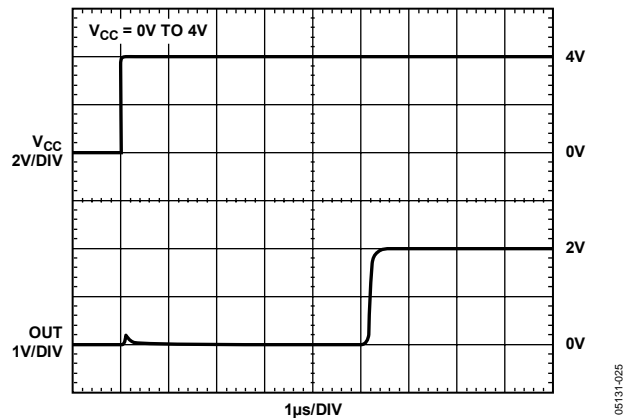

Figure 24. ADM4073T Start-Up Delay

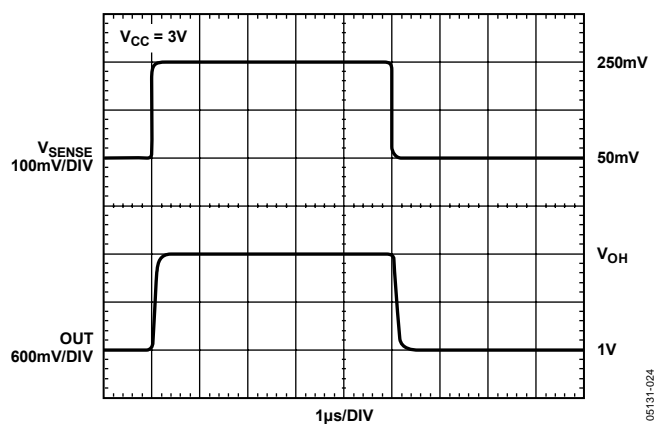

Figure 23. ADM4073T Overdrive Response

THEORY OF OPERATION

The current from the source flows through R_{SENSE} , which generates a voltage drop, V_{SENSE} , across the $RS+$ and $RS-$ terminals of the sense amplifier. The Input Stage Amplifier A1 regulates its inputs to be equal, thereby shunting a current proportional to V_{SENSE}/R_{G1} to the output current mirror. This current is then multiplied by a gain factor b in the output stage current mirror and flows through R_{GD} to generate V_{OUT} . Therefore, V_{OUT} is related to V_{SENSE} by the ratio of R_{G1} to R_{GD} and the current gain b .

$$V_{OUT} = A_V \times V_{SENSE}$$

where:

$$A_V = R_{GD}/R_{G1} \times b$$

where:

$$A_V = 20 \text{ V/V (for ADM4073T).}$$

$$A_V = 50 \text{ V/V (for ADM4073H).}$$

$$A_V = 100 \text{ V/V (for ADM4073F).}$$

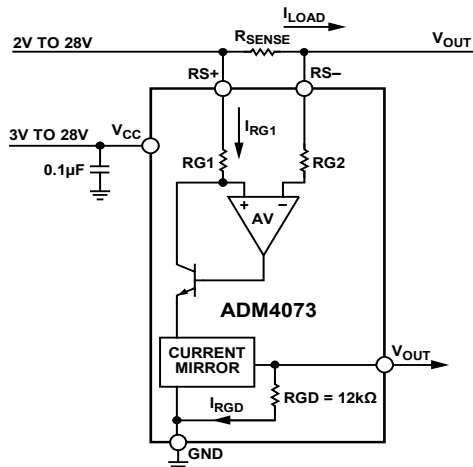

Figure 25. Functional Block Diagram

R_{SENSE}

The ADM4073 has the ability to sense a wide variety of currents by selecting a particular sense resistor. Select a suitable output voltage for full-scale current, for example, 10 V for 10 A. Then select a gain model that gives the most efficient use of the sense voltage range (150 mV max).

In the example above, using the ADM4073H (gain of 100) give an output voltage of 10 V when the sense voltage is 100 mV. Use the following equation to determine what value of sense resistor gives 100 mV with 10 A flowing through it:

$$R_{SENSE} = 100 \text{ mV}/10 \text{ A}$$

$$R_{SENSE} = 10 \text{ m}\Omega$$

$$V_{OUT} = (I_{LOAD} \times R_{SENSE}) \times A_V$$

To measure lower currents accurately, as large a sense resistor as possible should be used to utilize the higher end of the sense voltage range. This reduces the effects of the offset voltage errors in the internal amplifier.

When currents are very large, it is important to take the I^2R power losses across the sense resistor into account. If the sense resistor's rated power dissipation is not sufficient, its value can drift, giving an inaccurate output voltage, or it could fail altogether. This, in turn, causes the voltage across the $RS+$ and $RS-$ pins to exceed the absolute maximum ratings.

If the monitored supply rail has a large amplitude high frequency component, a sense resistor with low inductance should be chosen.

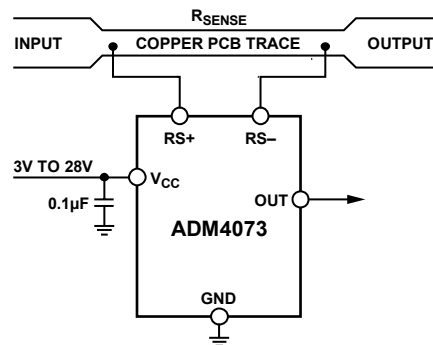

Figure 26. Using PCB Trace for Current Sensing

OUTPUT (OUT)

The output stage of the ADM4073 is a current source driving a pull-down resistance. To ensure optimum accuracy, care must be taken not to load this output externally. To minimize output errors, ensure OUT is connected to a high impedance input stage. If this is not possible, output buffering is recommended.

The percent error introduced by output loading is determined with the following formula:

$$\% \text{ Error} = 100 \left(\left(R_{LOAD} / R_{OUT_INT} + R_{SENSE} \right) - 1 \right)$$

where:

R_{LOAD} is the external load applied to OUT.

R_{OUT_INT} is the internal output resistance (12 kΩ).

OUTLINE DIMENSIONS

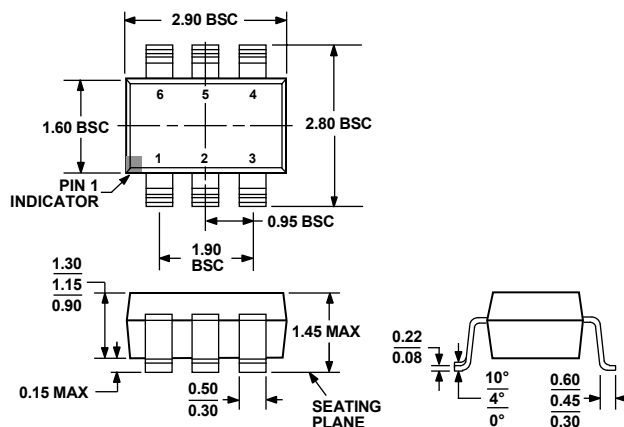

COMPLIANT TO JEDEC STANDARDS MO-178-AB

Figure 27. 6-Lead Small Outline Transistor Package [SOT-23] (RJ-6)

Dimensions shown in millimeters

ORDERING GUIDE

| Model | Gain | Temperature Range | Package Description | Package Option | Branding |
|---------------------------------|------|-------------------|---------------------|----------------|----------|
| ADM4073TWRJZ-REEL7 ¹ | 20 | -40°C to +125°C | 6-Lead SOT-23 | RJ-6 | M2E |
| ADM4073FWRJZ-REEL7 ¹ | 50 | -40°C to +125°C | 6-Lead SOT-23 | RJ-6 | M2C |
| ADM4073HWRJZ-REEL7 ¹ | 100 | -40°C to +125°C | 6-Lead SOT-23 | RJ-6 | M2D |

¹ Z = Pb-free part.

ADM4073

NOTES